

POGLED

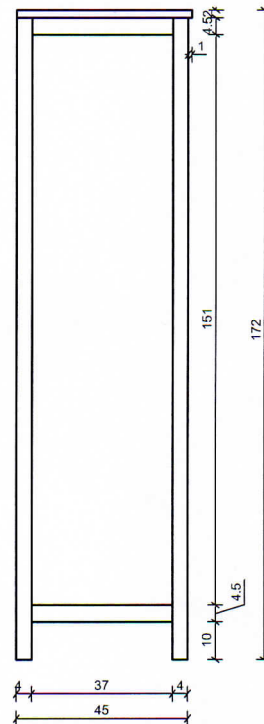

BOČNI POGLED

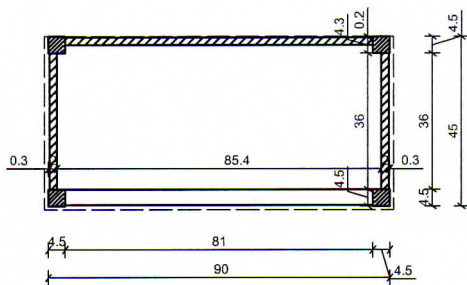

TLOCRT NIVO A-A

ZORAN POPOVIĆ  
ing.arh.  
OVLAŠTENI ARHITEKT  
A 1348

URED OVLAŠTENOG ARHITEKTA ZORAN POPOVIĆ B.Pericica 34, Šibenik		ZOP ML-36-2014
INVESTITOR	GRAD ORNIŠ	
GRADEVINA	REKONSTRUKCIJA MLINICE NA ČIKOLI	
FAZA	IZVEDBENI PROJEKT	
VRSTA PROJEKTA	ARHITEKTONSKI PROJEKT	
SADRZAJ	IZLOŽBENA VITRINA	
GLAVNI PROJEKTANT	ZORAN POPOVIĆ I.A.	
PROJEKTANT	MARTINA BARANIĆ d.i.s	
DATUM	06.2014	MJERILO 1:20
		LIST 22

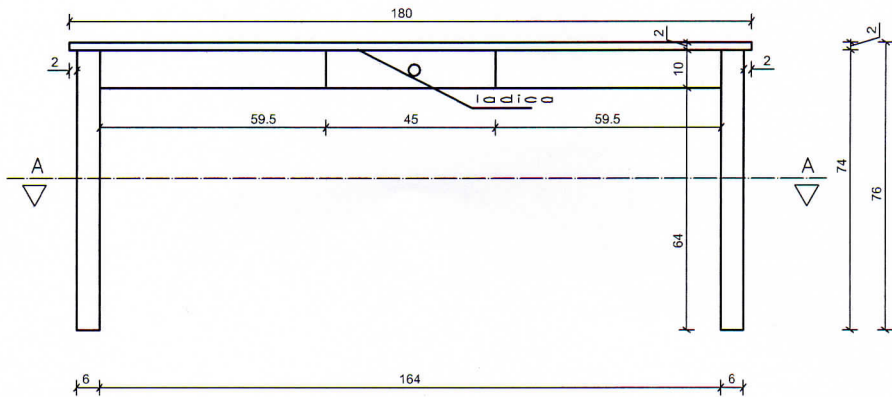

POGLED

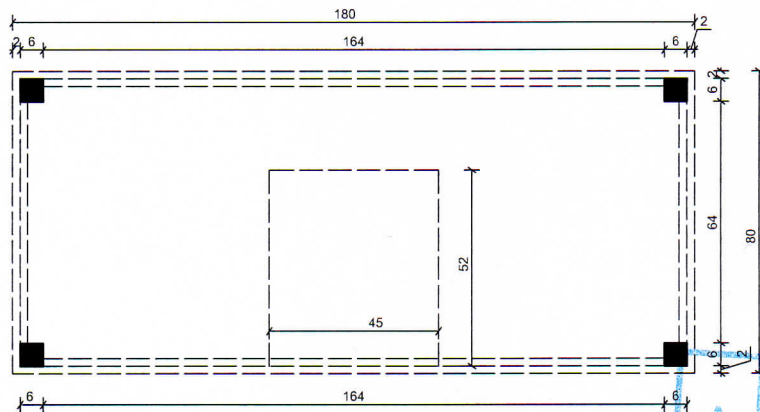

TLOCRT NIVO A-A

ZORAN POPOVIĆ  
ing.arh.  
OVLAŠTENI ARHITEKT  
A 1348

URED OVLAŠTENOG ARHITEKTA ZORAN POPOVIĆ B.Perićica 34, Šibenik		ZOP ML-36-2014
INVESTITOR	GRAD DRNIŠ	
GRADEVINA	REKONSTRUKCIJA MLINICE NA ČIKOLI	
FAZA	IZVEDBENI PROJEKT	
VRSTA PROJEKTA	ARHITEKTONSKI PROJEKT	
SADRZAJ	STOL	
GLAVNI PROJEKTANT	ZORAN POPOVIĆ I.A.	
PROJEKTANT	MARTINA BARANIĆ d.i.s	
DATUM 06.2014	MJERILO 1:20	LIST 23

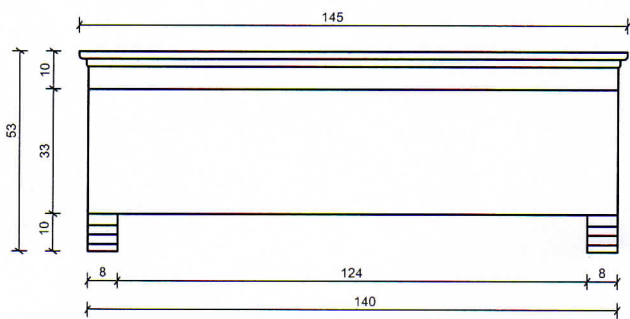

POGLED

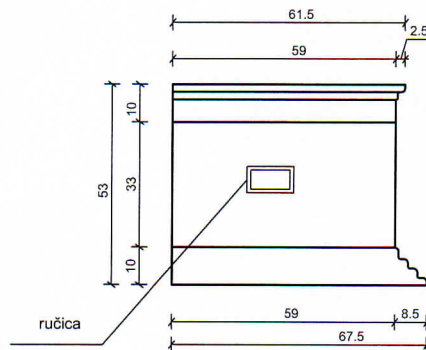

BOČNI POGLED

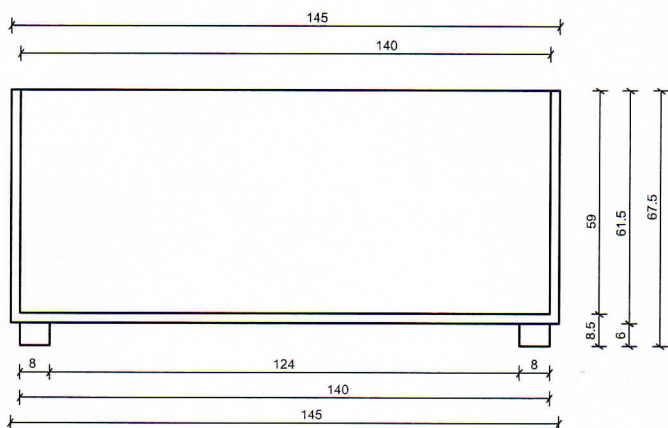

TLOCRT

ZORAN POPOVIĆ  
ing.arh.  
OVLAŠTENI ARHITEKT  
A 1948

21

URED OVLAŠTENOG ARHITEKTA ZORAN POPOVIĆ B.Pericica 34, Šibenik		ZOP ML-36-2014
INVESTITOR	GRAD DRNIŠ	
GRADEVINA	REKONSTRUKCIJA MLINICE NA ČIKOLI	
FAZA	IZVEDBENI PROJEKT	
VRSTA PROJEKTA	ARHITEKTONSKI PROJEKT	
SADRZAJ	ŠKRINJA	
GLAVNI PROJEKTANT	ZORAN POPOVIĆ I.A.	
PROJEKTANT	MARTINA BARANIĆ d.i.s	
DATUM 06.2014	MJERILO 1:20	LIST 24

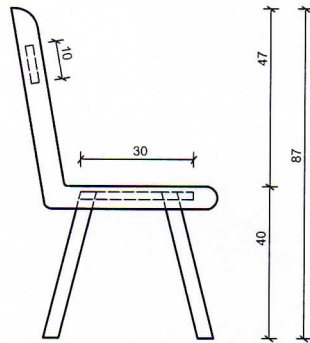
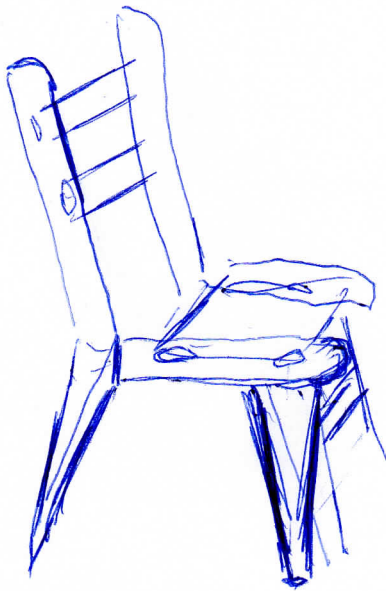

POGLED

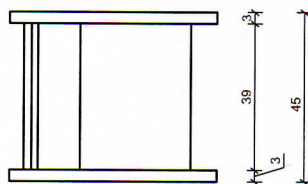

TLOCRT

**ZORAN POPOVIĆ**  
 ing.arh.  
 OVLAŠTENI ARHITEKT  
 A 1348

21

URED OVLAŠTENOG ARHITEKTA ZORAN POPOVIĆ B.Perićica 34, Šibenik		ZOP ML-36-2014
INVESTITOR	GRAD DRNIŠ	
GRADEVINA	REKONSTRUKCIJA MLINICE NA ČIKOLI	
FAZA	IZVEDBENI PROJEKT	
VRSTA PROJEKTA	ARHITEKTONSKI PROJEKT	
SADRŽAJ	STOLICA	
GLAVNI PROJEKTANT	ZORAN POPOVIĆ I.A.	
PROJEKTANT	MARTINA BARANIĆ d.i.s	
DATUM 06.2014	MJERILO 1:20	LIST 25